

# Data Sheet



Article number: 021816011095

Description: Clamp with bracket and rubber  
SPGU 6011. 95/30 SK

## Measures

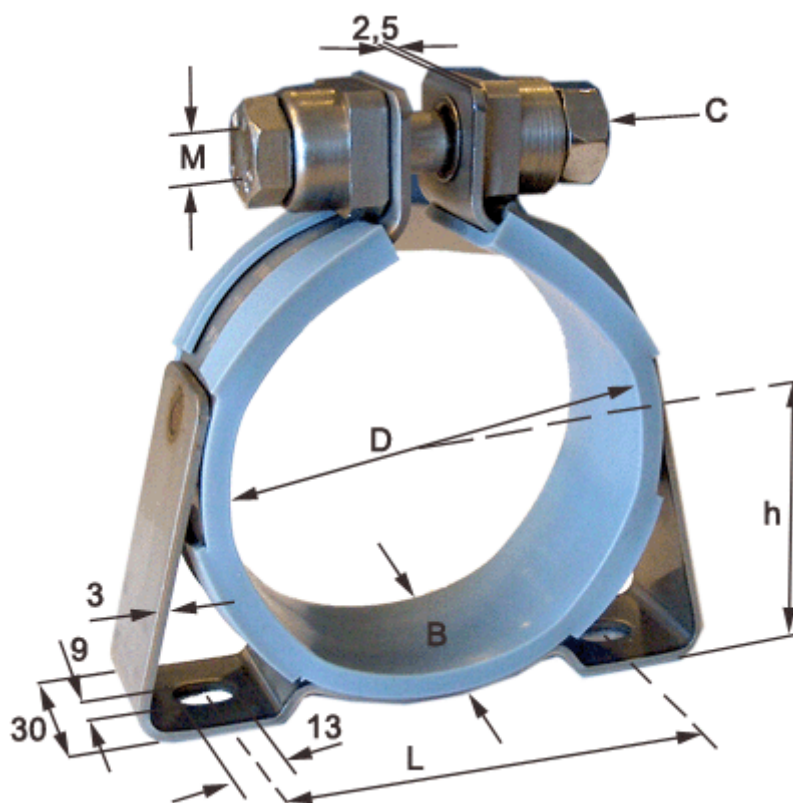

C (screw type) = SK hexagon screw

Diameter D = 95

h = 56

L = 90

Width B = 30